



PYROMOESA

Ghid montaj gratar modular



82cm latime

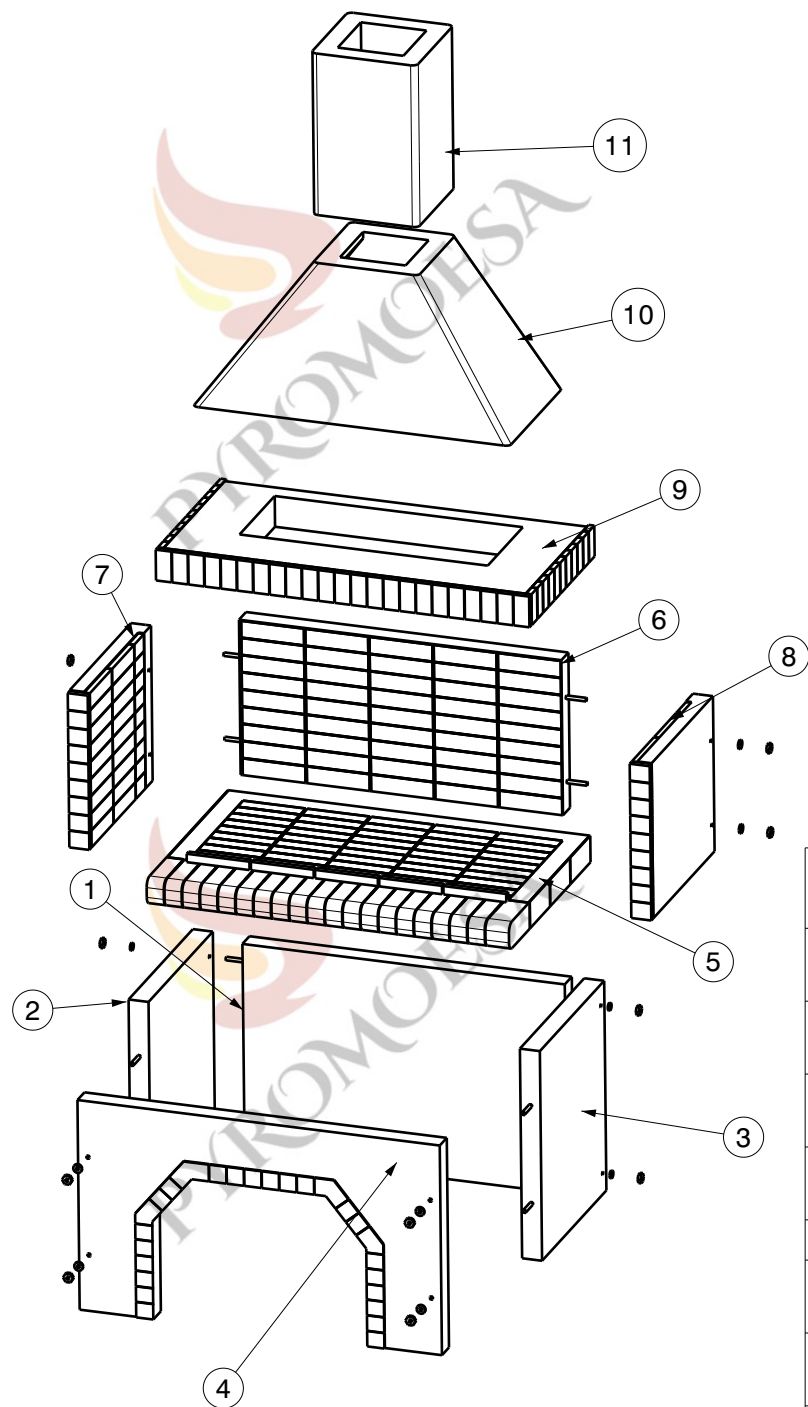

Nr. Crt.	Denumire	Dimensiuni [cm]	
		L	l
1	Picior spate	68	75
2	Picior stanga	63	75
3	Picior dreapta	63	75
4	Picior fata	82	75
5	Blat	82	76.5
6	Focar spate	68	55.5
7	Focar stanga	63	55.5
8	Focar dreapta	63	55.5
9	Etajera	86	63
10	Covata	-	-
11	Horn	25x25 int.	32x32 ext.

Nota:
 Dimensiunile contin tolerante de $\pm 0.5\text{cm}$
 La asamblarea finala trebuie luat in
 calcul si grosimea stratului de adeziv

Pas 1

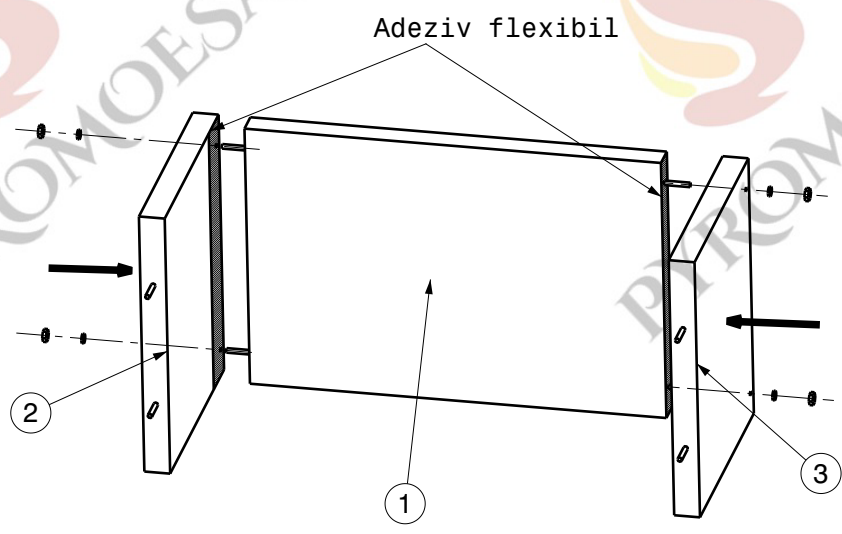

Pas 2

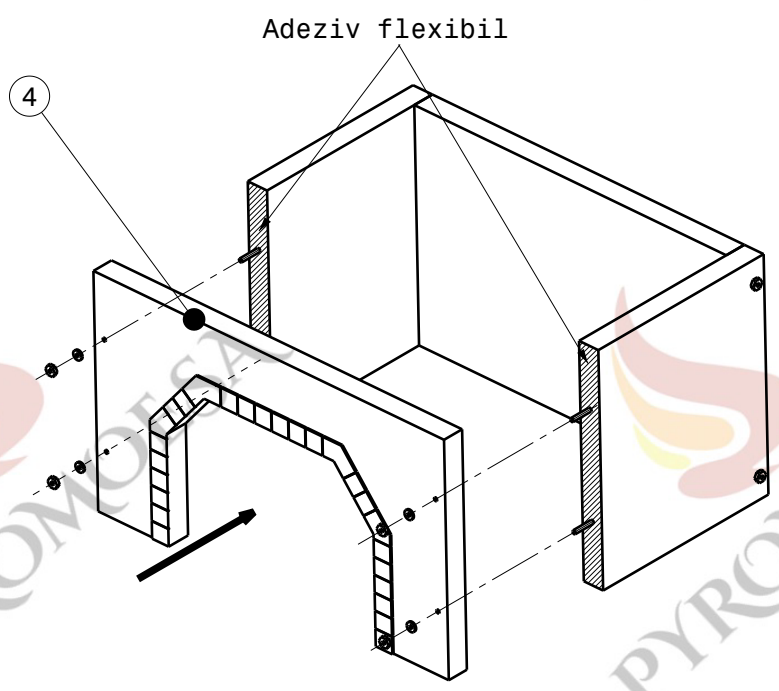

Pas 3

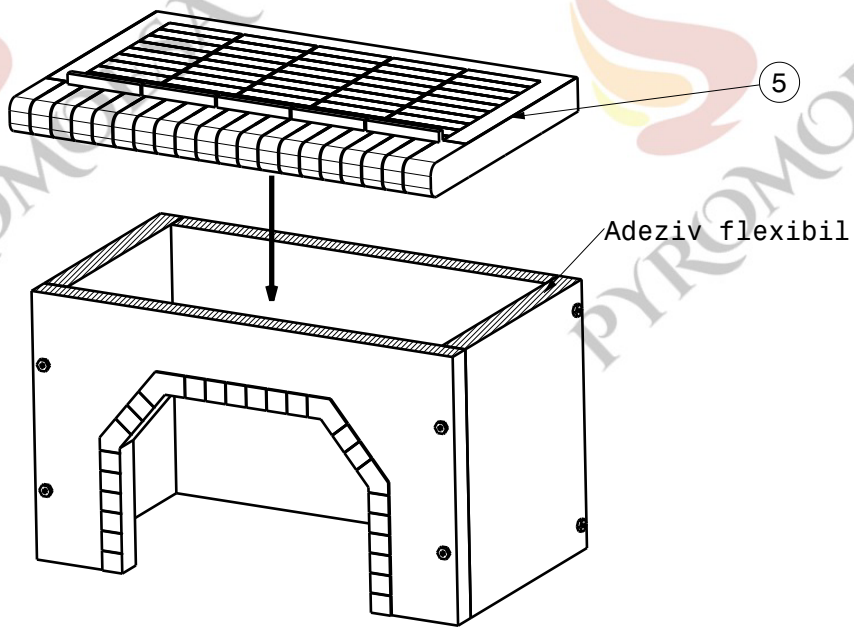

Pas 4

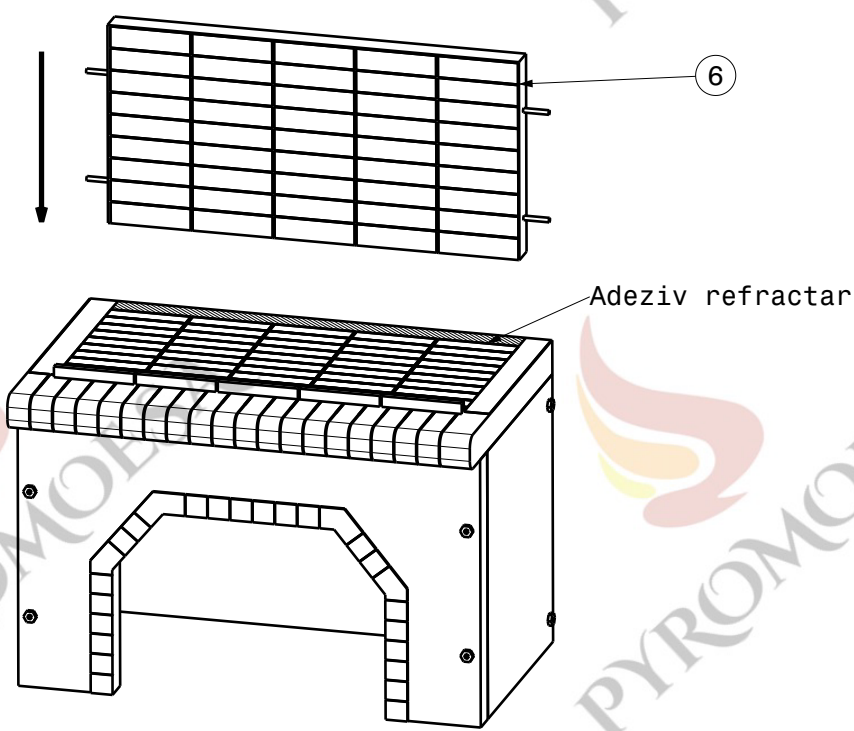

Pas 5.1

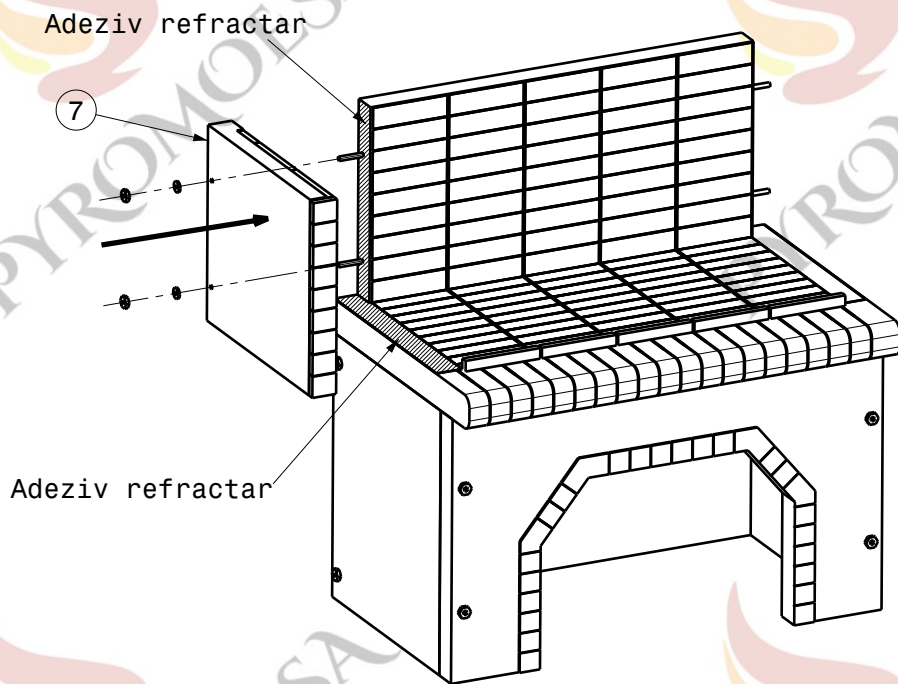

Pas 5.2

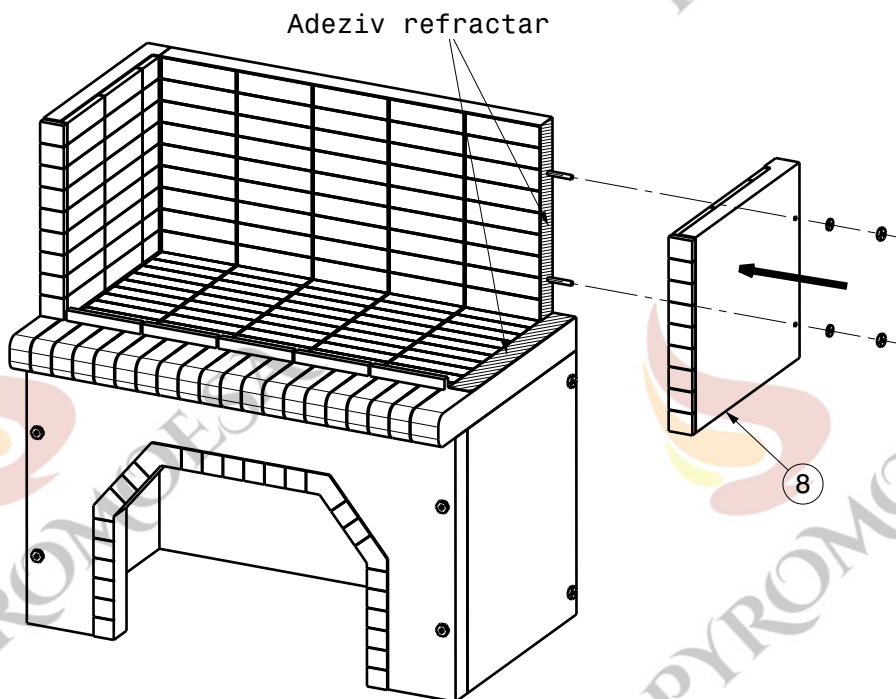

Pas 6

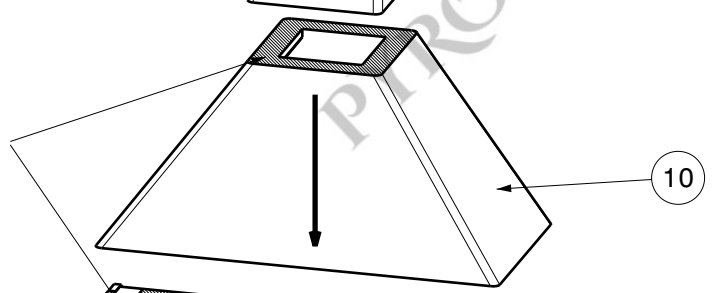
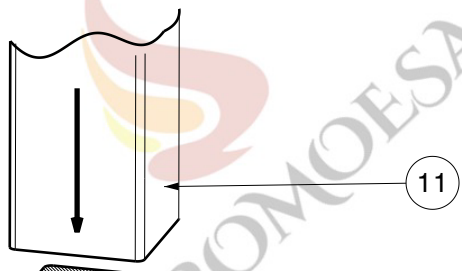
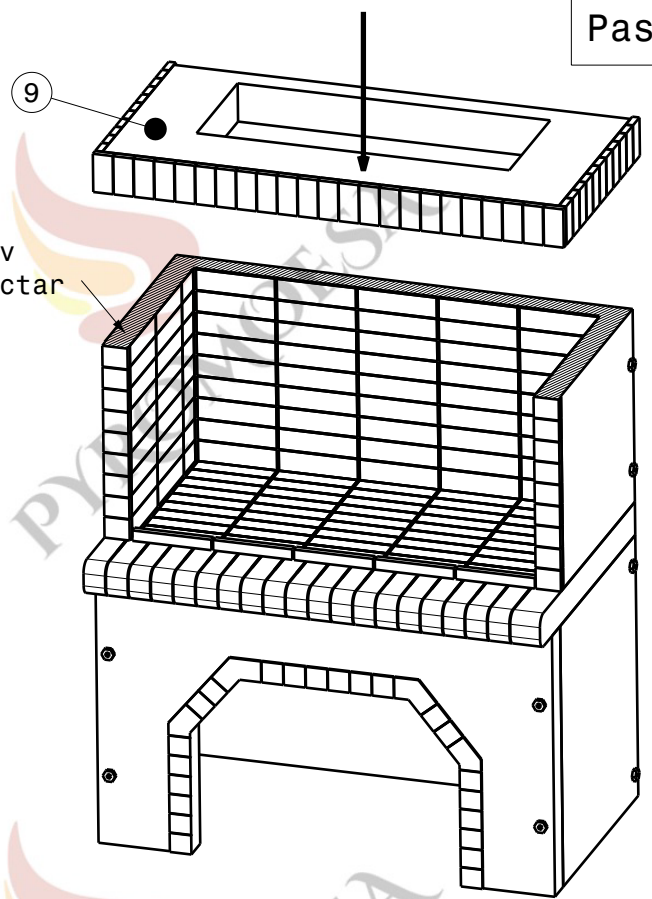

Pas 7

