



PYROMOESA

Ghid montaj afumatoare



Nota:
 Dimensiunile contin tolerante de 0.5cm.
 La asamblarea finala trebuie luat in calcul si grosimea stratului de adeziv.

Nr. Crt.	Denumire	Dimensiuni [cm]	
		L	l
1	Picior stanga	63	75
2	Picior spate	75	75
3	Picior dreapta	63	75
4	Cenurar-focar	80	54.5
5	Picior fata	90	75
6	Portita focar	ext. 28x25	int. 25x22
7	Blat	90	76.5
8	Focar spate	75	55.5
9	Focar stanga	63	55.5
10	Focar dreapta	63	55.5
11	Etajera	93	63
12	Horn	Exterior 21x21 Interior 15x15	
13	Usa afumatoare	75	51

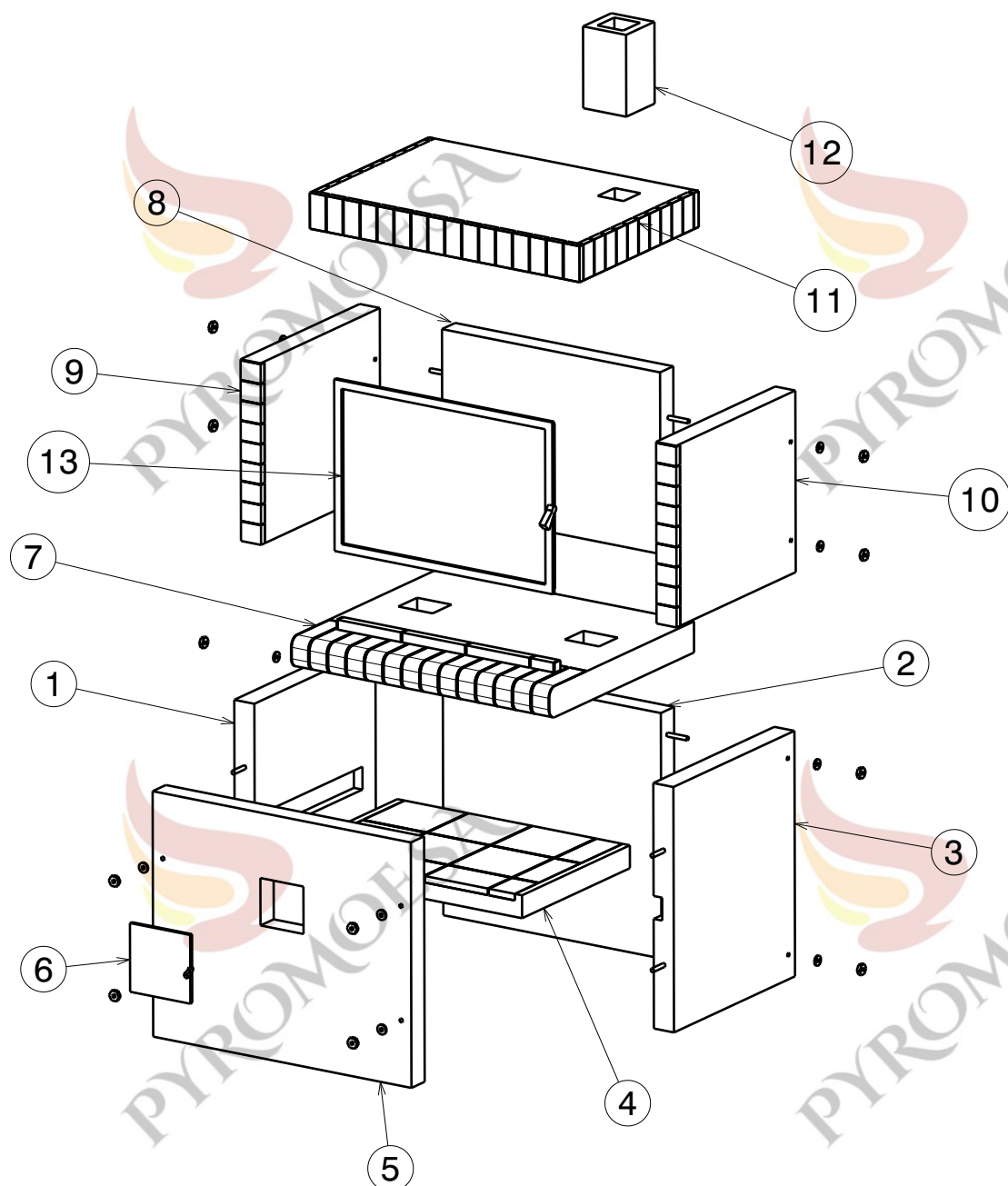

Pas 1

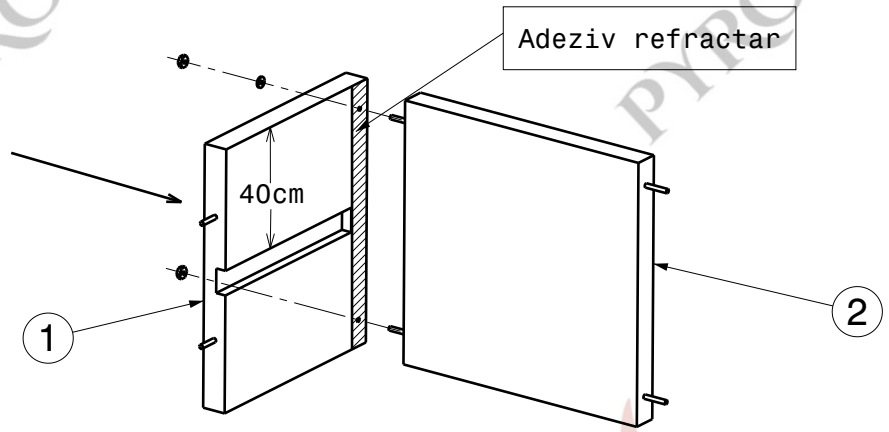

Pas 2

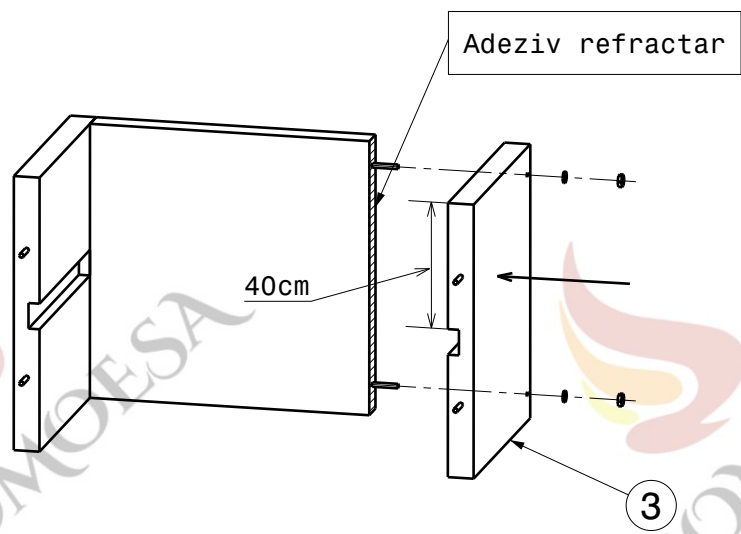

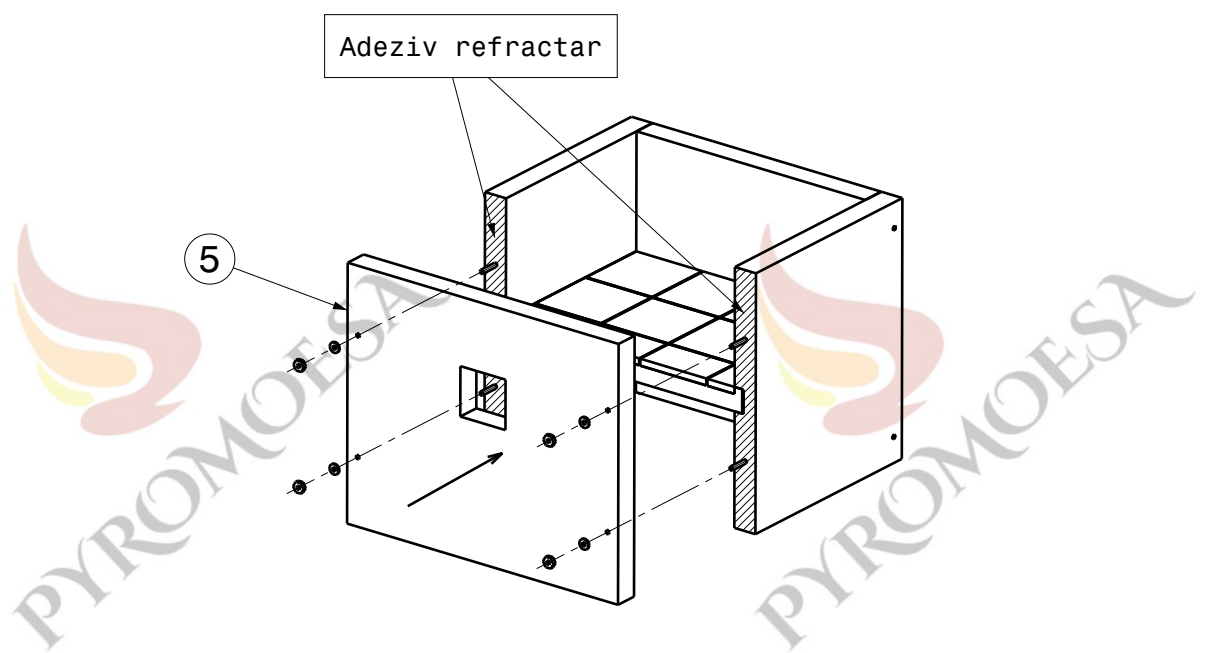
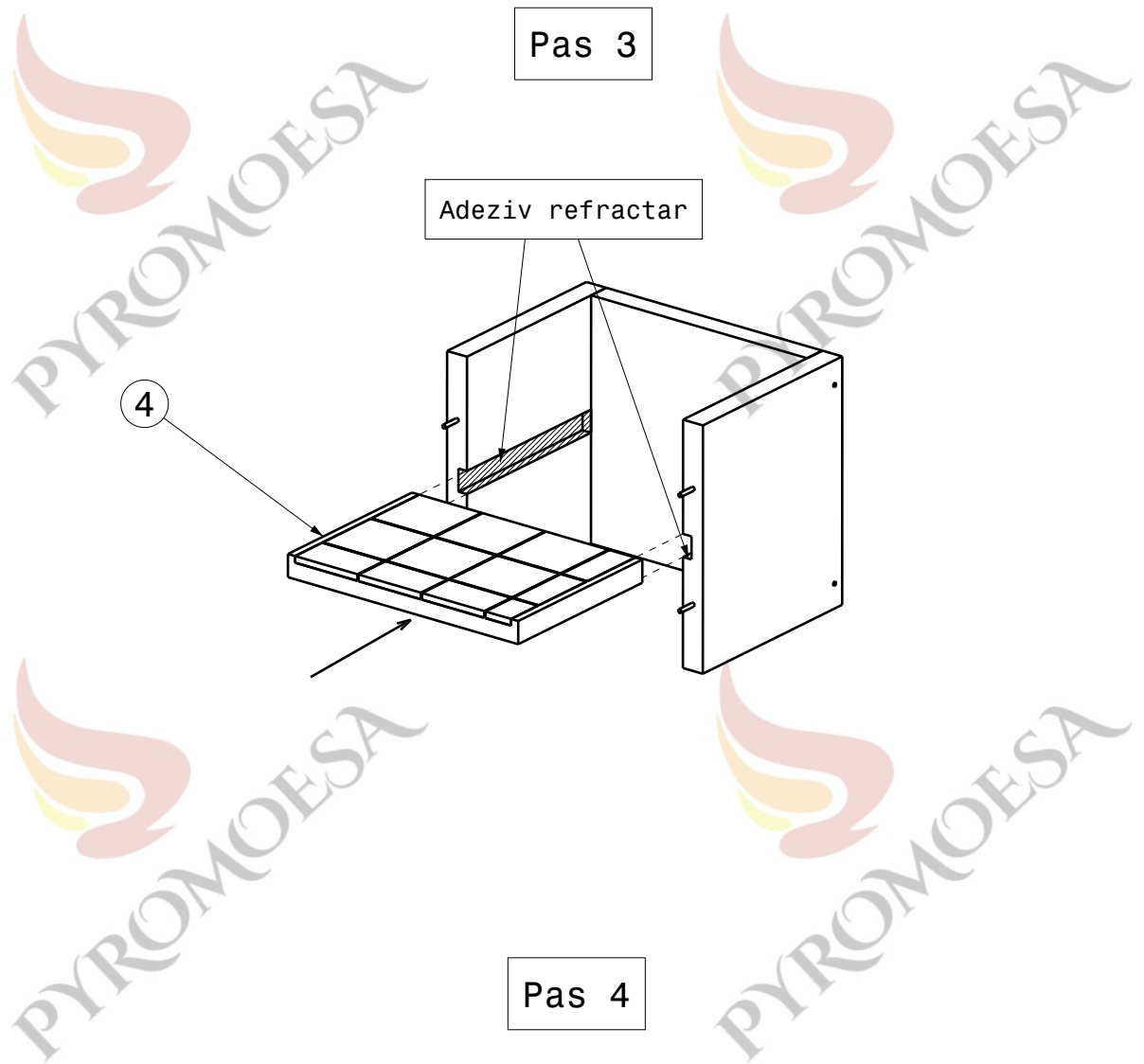

Pas 5

6

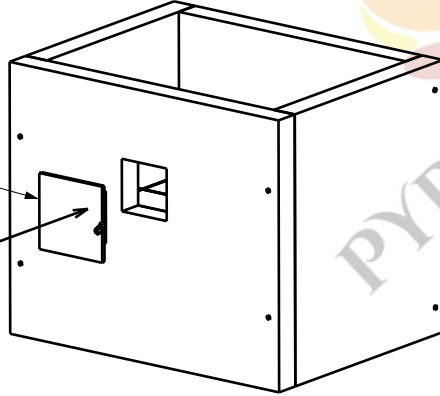

Pas 6

7

Adeziv refractar

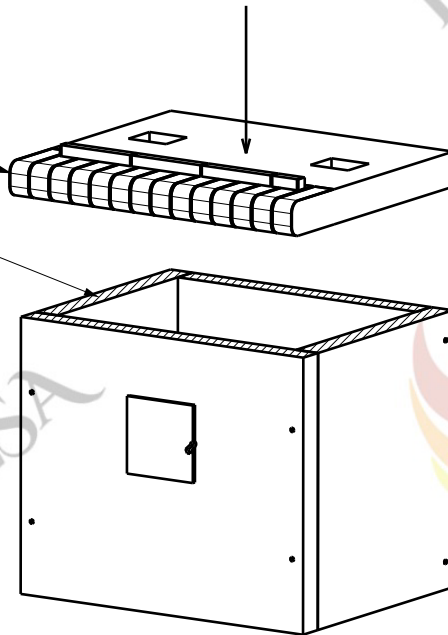

Pas 7

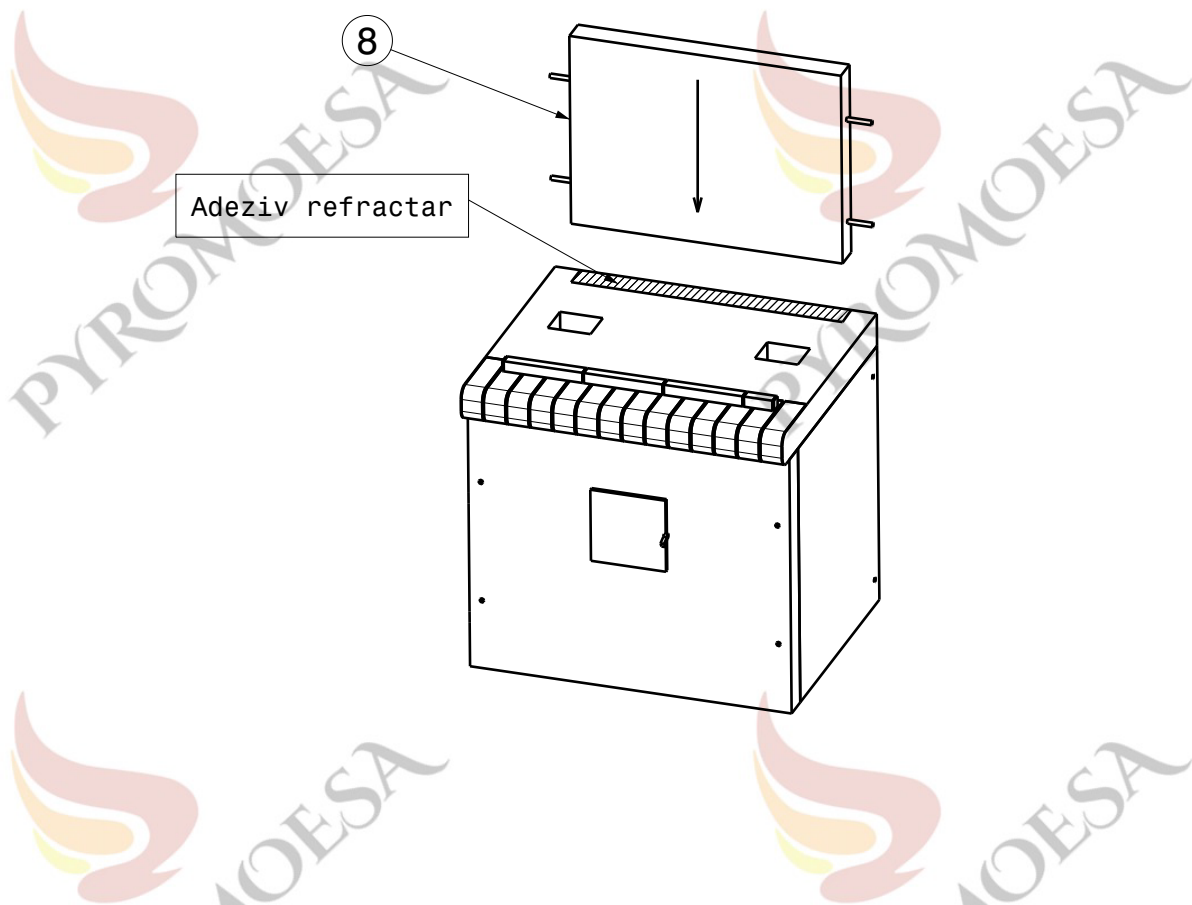

Pas 8

